

(B) ELEVATION

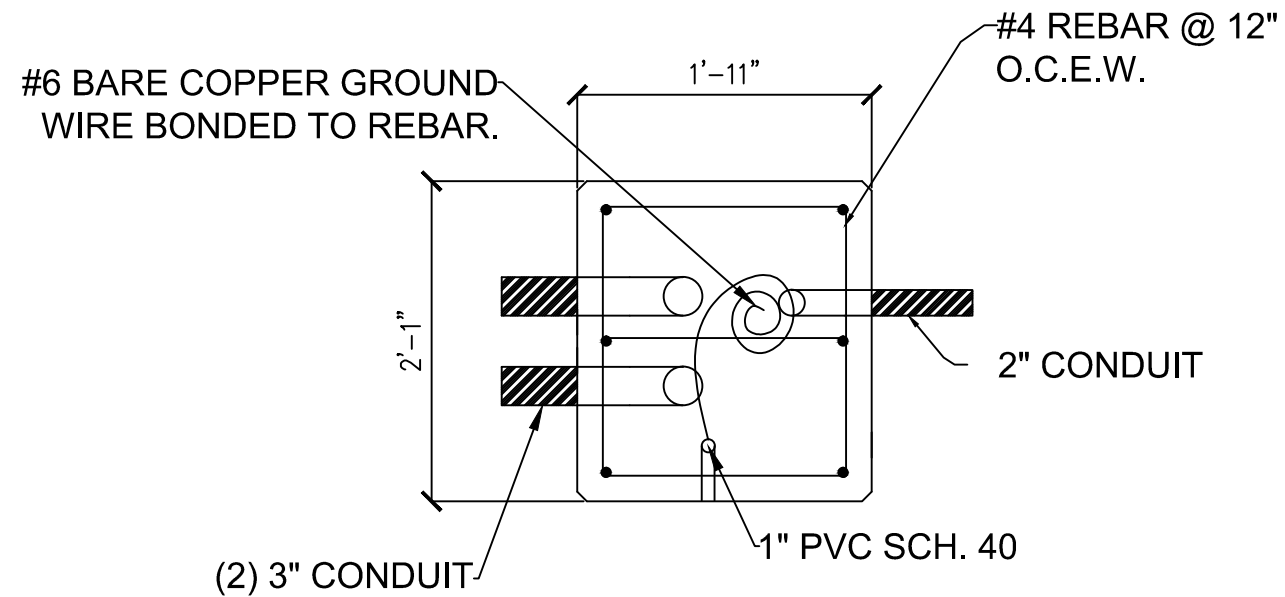

(A) 23" x 25" LOAD CENTER

PLAN
 -5,000 P.S.I CONCRETE
 REINFORCEMENT
 - ALL REBAR CONFORMS
 WITH ASTM A615, GRADE 60