

Installation Manual

For Horizontal Construction



Masonry made easy... and built buy you™

 **Moderra**[®]
Mortarless Masonry Veneer

IMPORTANT! Please read this entire installation manual prior to installing your Moderra® Concrete Veneer.

What you need to know about building Moderra®

Tools Needed..... 3
 Cutting Moderra Blocks 3
 Using Moderra Brackets 4
 Using Moderra Ties 4
 Fastening Moderra 5
 Engineering..... 8

Installation

Preparing the Wall..... 6
 Installing the Starter Ledge..... 7
 Installing & Making Moderra Corners 9 - 11
 Installing Moderra Blocks 12
 Bring Two Walls Together..... 13
 Finishing with Moderra Sill Blocks 14
 Doors & Windows..... 15 - 16
 Building 12" Moderra Pillars 17
 Moderra Ashlar Patterns 18

Moderra Components 19

General Information 20

Building Code requirements vary from area to area. Check with local authorities for building code requirements in your area. Carefully read all installation guidelines before proceeding with your Moderra Concrete Veneer application. Observe safety precautions.

The information and product applications illustrated in this manual have been carefully compiled by Alliance Concrete Concepts, Inc. and to the best of our knowledge accurately represent Moderra Concrete Veneer product use. Final determination of the suitability of any information or material for the use contemplated and its manner of use is the sole responsibility of the user.

TOOLS NEEDED

- Safety Glasses & Dust Mask
- Hammer
- Saw with Diamond Blade
- Dead-blow Rubber Hammer
- Masonry Chisel
- String Line & Measuring Tape
- Power Screw Driver
- Hammer Drill
- 2 lb. Hammer
- Level (4' and 8")
- Caulking Gun
- Whisk Broom

CUTTING MODERRA®

As you build with Moderra, you will need to cut the Moderra concrete units and/or Trim Channels. You can use either a wet or a dry saw with masonry blades.

After cutting Moderra units, thoroughly wash them with water or air pressure to remove all cement dust. Dust will cause staining if not removed.

Moderra 8" and 4" Blocks are specifically designed with an Atmospheric Gasket on top of the unit. The Gasket allows the Block to be cut to any length and still be used in conjunction with a Moderra Tie. See **BRINGING TWO WALLS TOGETHER**, pg. 13.

Note: Remember to follow proper safety procedures when cutting. This includes, but is not limited to, safety glasses, dust mask, and ear plugs.

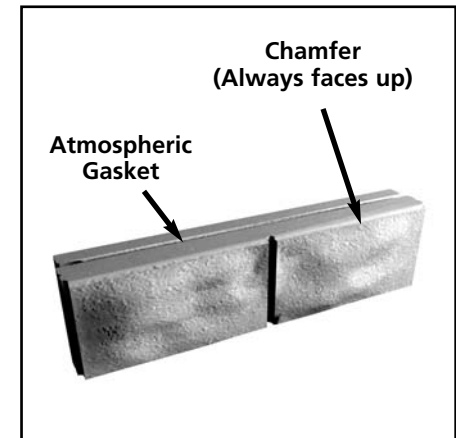
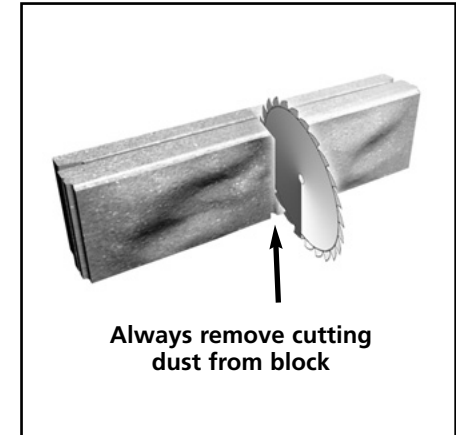

USING THE MODERRA BRACKET

The Moderra Bracket allows you to build Moderra horizontally to create a running bond appearance. Made of galvanized steel, this patent pending Bracket locks Moderra Blocks together, affixing them to the wall and creates a 3/4" airspace that lets the wall breath.

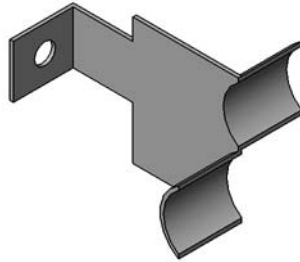

USING MODERRA TIES (optional)

When building a Moderra wall, you will need to cut Blocks. Always use a Moderra Tie on cut Blocks for added stability. To install the Moderra Tie, place the short end into the Atmospheric Gasket. Then attach the cut Moderra Block Tie to the wall. This will ensure the cut Block does not move.

Gluing the back of a cut Block to a Trim Channel will provide a strong connection. Therefore, use of the Moderra Tie is completely optional.

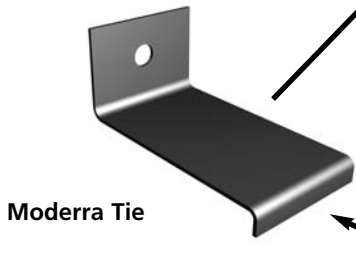
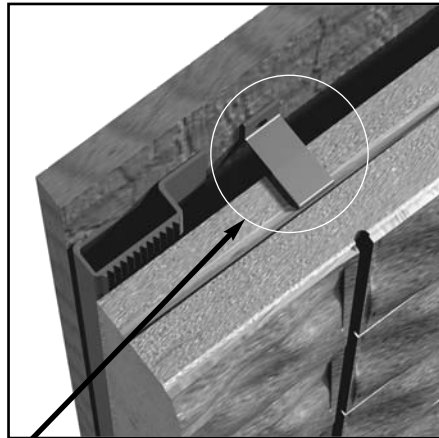

Moderra Tie

The short end goes into the Atmospheric Gasket.

FASTENING MODERRA

Because Moderra can be installed on a variety of different wall surfaces, different fasteners may be required. In most situations, space the fasteners on Trim Channels every 24".

IMPORTANT!
Please read this entire installation manual prior to installing your Moderra Concrete Veneer.

WALL SURFACE	MODERRA BRACKET and TRIM CHANNEL FASTENERS*
Rigid Backwall	1" Standard Screw with 1/4" Hex head drive or 1" Post Frame Screw
Concrete, Masonry, or Stucco	3/16" x 1-1/4" Concrete or Masonry Screw
Metal Buildings	1" Standard Screw with 1/4" Hex head drive or 1" Post Frame Screw

* Wall anchorage requirements should be coordinated with the construction contractor.

Moderra's design charts are for preliminary use only. A final site specific design should be evaluated and approved by a qualified professional engineer.



www.moderra.com

PREPARING THE WALL

Preparing for your Moderra installation depends on the type of wall surface it is going on. Wall preparation is specific for these three wall types:

<p>Rigid Backwall – Plywood – Paneling – Wall Sheathing – Concrete Board</p>	<p>Cover your wall with building paper and lap the joints by 4", shingle fashion. Continue to wrap a weather-resistant barrier a minimum of 16" around all outside and inside corners.</p>
<p>Concrete, Clean & Untreated</p>	<p>No preparation needed if the wall(s) are in good condition.</p>
<p>Renovation, Metal Buildings</p>	<p>Remove a 3" high section the entire length of your wall, 1/2" above your future Moderra Concrete Veneer. This will leave room for flashing. It is optional to remove the metal cladding covering your entire wall area. If so, apply a rigid backboard and follow the necessary interior and exterior requirements as outlined.</p>

Note: Before you begin your Moderra installation, check the wall to make sure it is vertically and horizontally level. If not, you may need to plumb the wall so the Moderra installs properly.

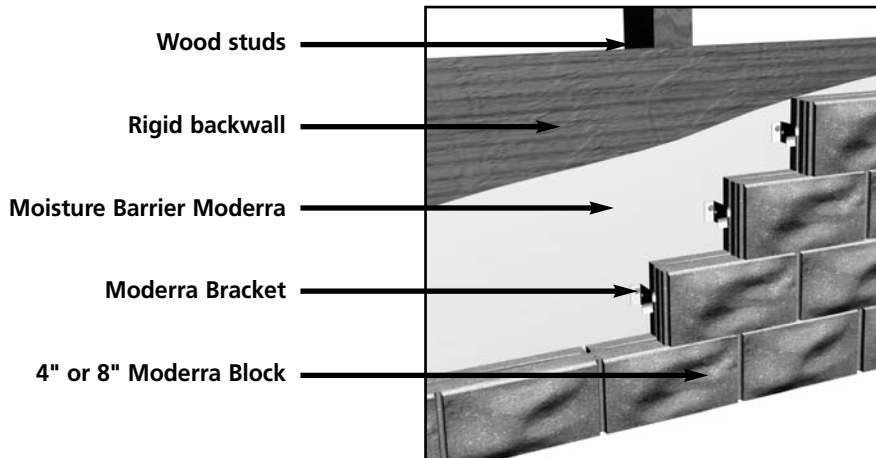

INSTALLING THE STARTER LEDGE

Moderra needs a strong level base for construction. Use Moderra Starter Ledge, angle iron, or a level brick ledge.

Starter Ledge is a predrilled 3" steel angle designed to hold your Moderra wall. If you are using generic steel angle, be sure it is a minimum of 3" x 3" x .25".

First, level your Starter Ledge or angle iron using a 4' level for best results. Next, attach the Starter Ledge or angle to your wall surface every 8", 12" or 16".

When using the Starter Ledge or angle iron on a post frame building, do not connect them directly to your building's posts. Instead, they should be screwed to a 2 x 6 or 2 x 8, which in turn is connected to the posts.

On metal building applications, Starter Ledge can be welded to the building's base angle.

When installing Moderra on a brick ledge, you can use a Starter Ledge and level it with shims. In that situation, you do not need to attach the Starter Ledge to the wall.

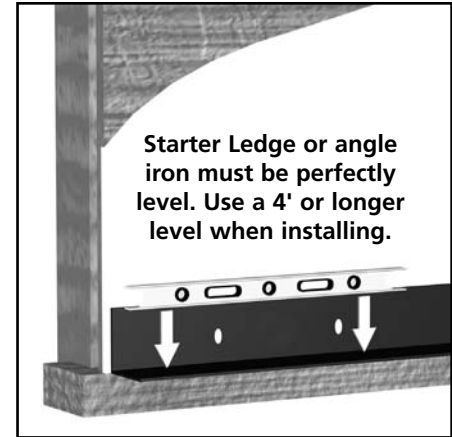

Starter Ledge or angle iron must be perfectly level. Use a 4' or longer level when installing.

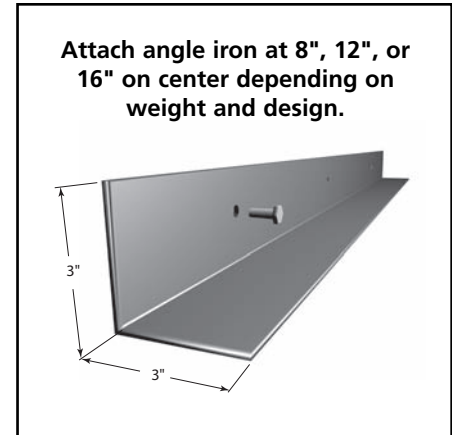

Attach angle iron at 8", 12", or 16" on center depending on weight and design.



www.moderra.com

ENGINEERING

The maximum recommended height of your Moderra wall will be determined by the Starter Ledge or angle iron connection. Use the following table to determine the maximum height for your Moderra application. Consult a structural engineer if you desire to build higher than the maximum heights indicated below.

BUILDING TYPE	APPLICATIONS*
Any	Starter Ledge placed on top of concrete footing or brick ledge. MAX. HEIGHT, WITH SILL BLOCK = >16' <i>(Limited by footing design)</i>
Wood Frame Building <i>(angle iron attached to concrete footing)</i>	Starter Ledge attached to concrete footing or concrete stem wall, using 1/2" x 3" concrete anchor bolts/screws at 16" o.c.. MAX. HEIGHT, WITH SILL BLOCK = 12'
Wood Frame Building <i>(angle iron attached to studs)</i>	Starter Ledge attached thru OSB/plywood to studs, using 3/8" x 3" fully threaded lag screw at 16" o.c.. MAX. HEIGHT, WITH SILL BLOCK = 6'
Post Frame Building (8' Post Spacing)	Starter Ledge attached at ends thru OSB/plywood and base girt into posts with 1/2" x 6" lag screws; and attached thru OSB/plywood into base girt, using 3/8" x 3" fully threaded lag screws at 16" o.c.. MAX. HEIGHT, WITH SILL BLOCK = 6'

* Starter Ledge anchorage requirements should be coordinated with the construction contractor.

Moderra's design charts are for preliminary use only. A final site specific design should be evaluated and approved by a qualified professional engineer.

INSTALLING 4" MODERRA CORNER UNITS

Installing Moderra works best when you start at the end of the wall and move toward the center. This minimizes the visibility of any cut pieces.

Starting - Outside Corner

Start by placing the first offset Corner Block on top of the two adjoining Starter Ledges. Make sure the Starter Ledges are level with each other and the chamfer on the Corner Block is facing up. Next, verify the Corner unit is level before proceeding. Attach a Moderra Bracket on each side of the Corner Block. For details, see **FASTENING MODERRA**, pg. 5.

For the second course, use the opposite Corner Block to start the running bond style.

Continue building the wall. Attach a Bracket to the side of each unit as you build.

Note: Use shims when necessary to keep Moderra units level.

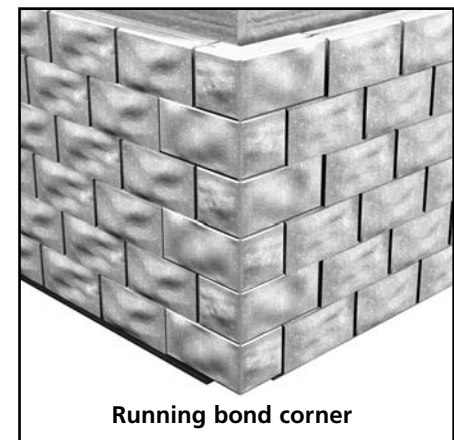
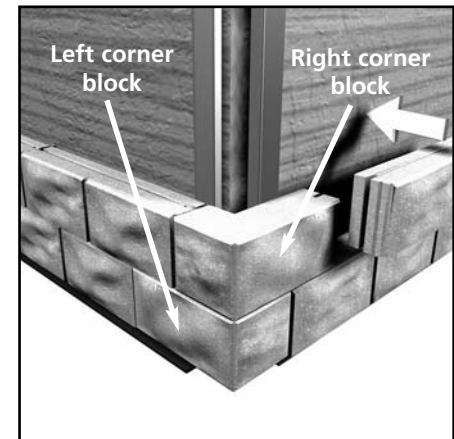
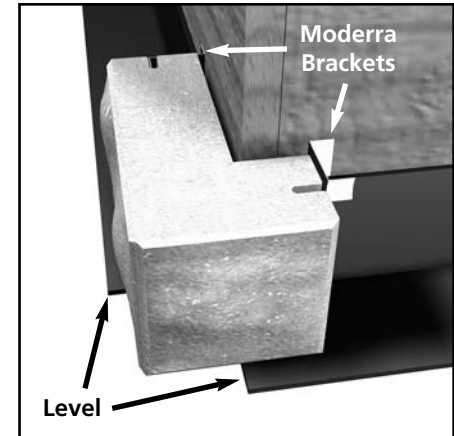

Starting - Inside Corner

Begin by attaching a Trim Channel 4" to 5" from the corner. Next, add a second Trim Channel to the adjoining wall. The second Trim Channel should be 4" to 5" from the edge of the corner. The Trim Channels should be attached to the wall every 24". For details, see **FASTENING MODERRA**, pg. 5.

Build the two courses separately. The first Blocks on the left and right sides of the 1st course are full length Blocks. On the second course, the first two Blocks will need to be cut. Alternate your courses this way until you reach the desired height.

Note: After cutting Moderra Blocks, clean thoroughly with water or air pressure to remove all cement dust. Dust will cause staining if not removed.

Always apply a thin layer of Super-Stik on the back of the Trim Channels. This will adhere the units to the wall. You can also insert a Moderra Tie into the block.

Note: When building with Moderra Blocks, make sure the Atmospheric Gasket and chamfer always face up.

Ending - Inside Corner

You can also end your Moderra project at an inside corner. First, attach a Trim Channel approximately 4" to 5" from the corner's edge.

Next, add another Trim Channel to the adjoining corner approximately 4" to 5" from the edge. For details on attaching the Trim Channels, see **FASTENING MODERRA**, pg. 5.

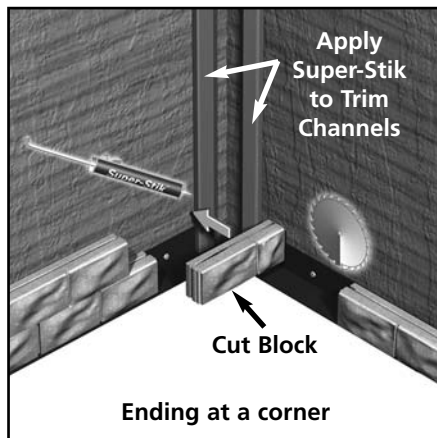
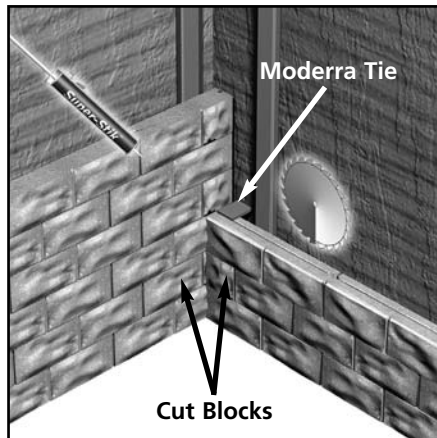
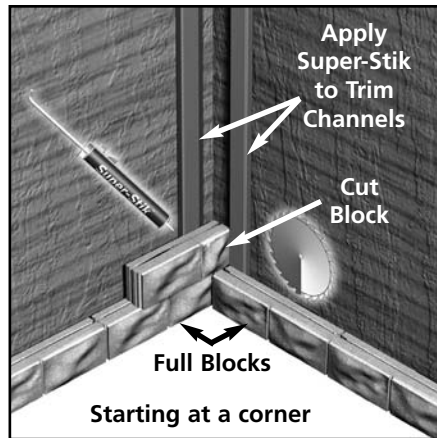

You can build the two courses separately or together. Cut your Moderra units so they will fit snugly in the corner. Apply a thin layer of Super-Stik to the Trim Channel. This will adhere the units to the Trim Channel. Tap them into place and level. Additionally, you can insert a Moderra Tie into the cut block. Continue this process until your inside corner is complete. For details, see **USING MODERRA TIE**, pg. 4.

Note: Use shims when necessary to keep Moderra units level.

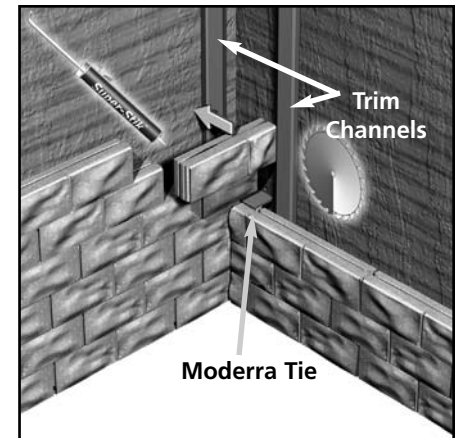

MAKING CORNER BLOCKS

If you are building a 8" no-score running bond wall, you will need to cut corners and blocks.

To create the running bond corner, cut 4" off one side of both a Corner Block and a full Moderra Block. Do the same to the opposite side of two additional units for the next course.

Apply Trim Channel on both sides of the wall where the cut units meet. Apply a thin layer of Super-Stik to secure each unit to the wall.

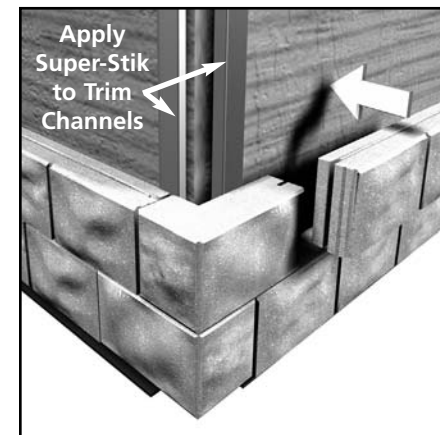
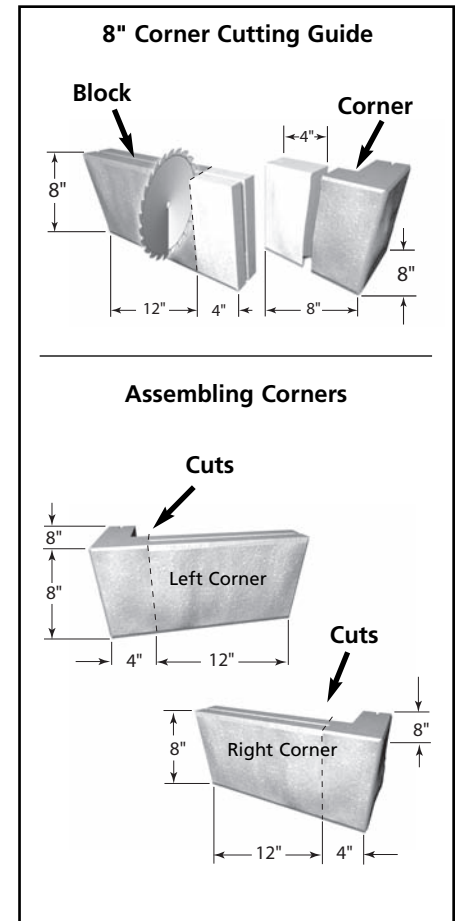

INSTALLING MODERRA BLOCKS HORIZONTAL

Once you have installed your initial corner, you can now apply Moderra units. Moderra's innovative Bracket technology allows the units to be installed horizontally.

No Corner

If your wall does not involve a corner, start by affixing a Trim Channel to the wall. Next add a full unit on the first course, and cut 4" or 8" off the first unit on the second course to create a running bond appearance.

Apply a thin layer of Super-Stik to the Trim Channel. Additionally, you can insert a Moderra Tie into the block. This type of installation may require flashing to finish off the side of the Moderra wall.

Note: When building with Moderra Blocks, make sure the Atmospheric Gasket and chamfer always face up.

Complete the Moderra Wall

Level each block on the top and side to ensure a straight wall and to minimize seams between the units and courses. Sweep the top of each block to remove all dust and debris before installing the next course. Once you reach your desired height you are ready for the Moderra Sill Block. For details, see **FINISHING WITH MODERRA SILL BLOCK**, pg. 14.

Note: Use shims when necessary to keep Moderra Blocks level.

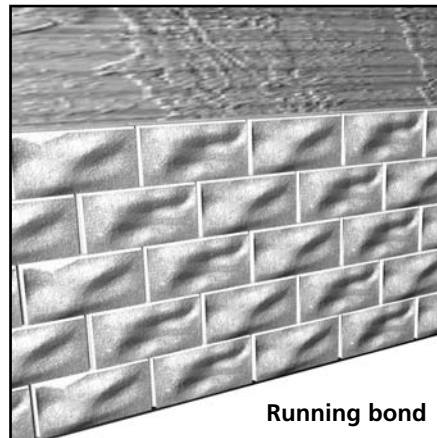
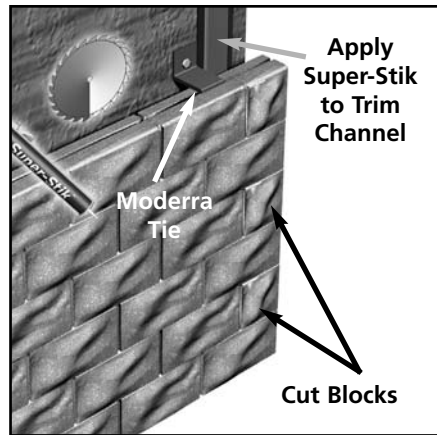

BRINGING TWO WALLS TOGETHER: HORIZONTAL CONSTRUCTION

You will need to cut Moderra Blocks to fit when joining two walls together. Place the cut Moderra Blocks and Trim Channels at different points for each course. Connecting each course at a different spot in the wall will help to hide the seams.

Cut Trim Channel to 3" or 4" pieces to use as a 3/4" spacers and apply Super-Stik to the Trim Channel so the blocks adhere to the Channel. Additionally, a Moderra Tie can be used for more security.

Repeat this step until the wall is at the desired height.

Note: After cutting Moderra Blocks, clean thoroughly with water or air pressure to remove all cement dust. Dust will cause staining if not removed.

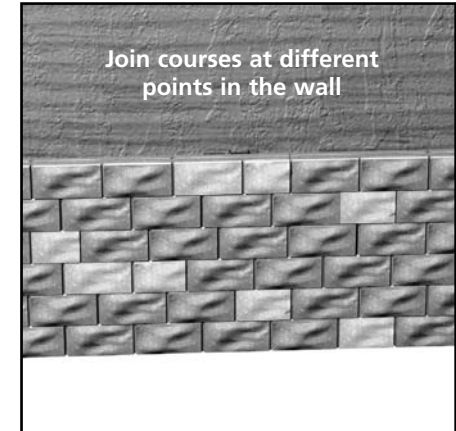
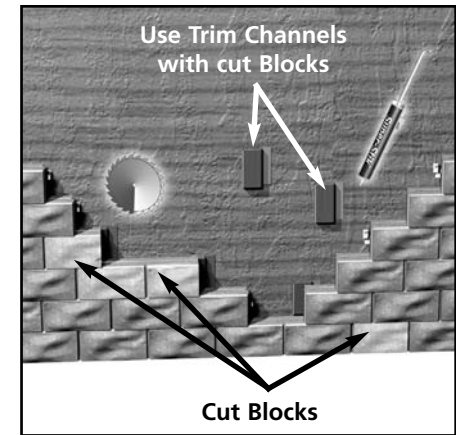

FINISHING WITH MODERRA SILL BLOCKS

First, install flashing at the bottom of your existing siding. This will help to prevent moisture from falling behind your Moderra wall.

Next, apply a thin layer of Super-Stik concrete adhesive to the top of the Moderra Blocks and on the side of the Moderra Sill Block. This will secure the units into place. Set the Moderra Sill Block onto the glue and tap into place. Continue gluing and placing the Sill Blocks until finished.

At outside and inside corners, fit Moderra Sill Blocks with a 45° miter cut. For details, see **CUTTING MODERRA**, pg. 3.

Once the Sill Blocks are in place, your finished Moderra wall is finished.

Note: When using a product other than the Moderra Sill Block, refer to that product's installation guidelines.

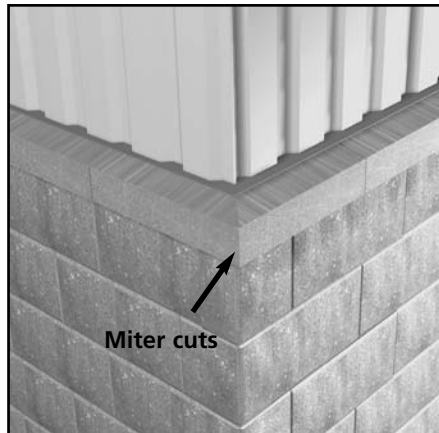
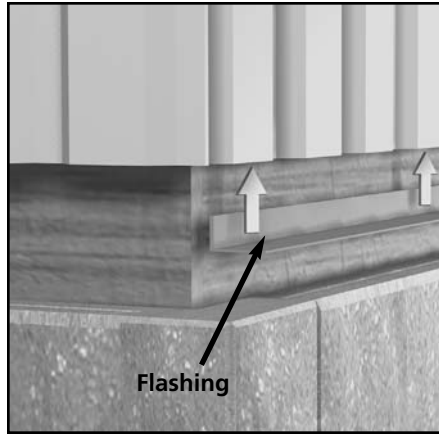

ENCOMPASSING DOORS

Start by fastening Trim Channels along the outside edge of the door. Next, if your Moderra wall is going to extend above the door, attach a Starter Ledge or angle iron at the top. For details, see **INSTALLING THE STARTER LEDGE**, pg. 3.

Now that your door is prepared, cut your Moderra units to the length needed.

Apply a thin layer of Super-Stik to the Trim Channel and install the cut units into the corresponding Moderra Bracket. Alternatively, you can use a Moderra Tie. For details, see **USING MODERRA TIES**, pg. 2.

Continue up the wall until past the door. Once past the door, cut the block to the proper length and height to go on the Starter Ledge and continue.

Proceed up the opposite side of the door in the same way you did the first. Cut the Moderra units so they will be the same length as the 8" or 4" units on the top of the door.

When the door is finished, place flashing or caulking between the door and the Moderra units to prevent moisture from falling behind the wall.

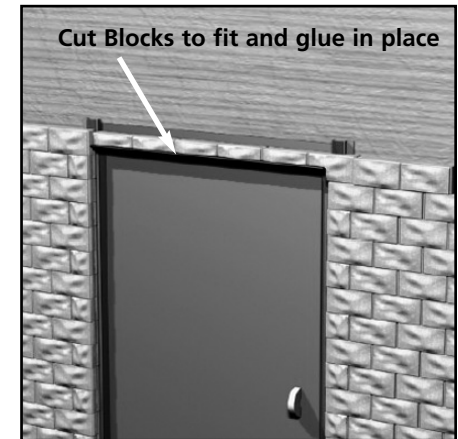
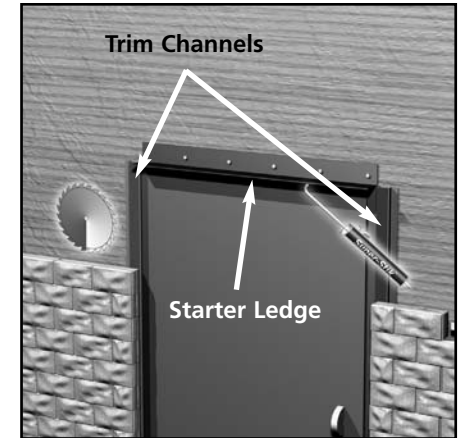

ENCOMPASSING WINDOWS

Start by fastening Trim Channels along the outside edge of the window. Next, if your Moderra wall will extend above the window, attach a Starter Ledge or angle iron at the top. For details, see **INSTALLING THE STARTER LEDGE**, pg. 7.

Now that your window is prepared, cut your Moderra units to the proper length.

Apply a thin layer of Super-Stik to the Trim Channel and install the cut units into the corresponding Moderra Bracket. Alternatively, you can use a Moderra Tie. For details, see **USING MODERRA TIES**, pg. 4.

Continue up the wall until past the window. Once past the window, cut the Block to the proper length and height to go on the Moderra Starter Ledge and continue.

Proceed up the opposite side of the window in the same way you did the first. Cut the Moderra Blocks so they will end at the same length as the Blocks at the top of the window.

When building your wall beneath a window, finish with a 4" space between the top of the wall and the bottom of the window. This space is needed for the Moderra Sill. Sill Blocks should be installed under the window and glued into place using Super-Stik.

When the window is finished, place flashing or caulking between the window and the Moderra units to prevent moisture from falling behind the wall.

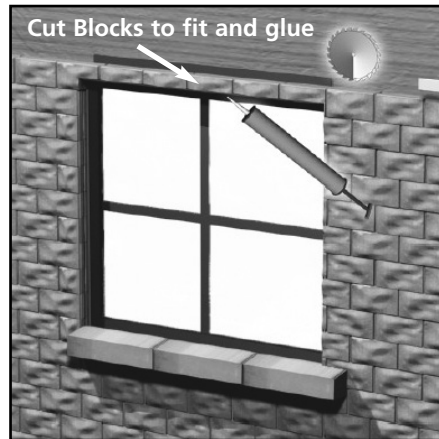
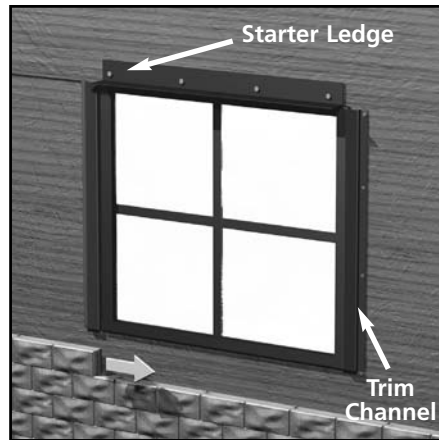

BUILDING A 12" MODERRA PILLAR

The standard Moderra brick pillar is 12" square (outside dimension) with a 8" square interior.

Begin by furring out your support to accommodate the inside dimension of your Moderra pillar. Use 4" left Corner Block on the 1st course and use 4" right Corner Block on the 2nd course. To increase the dimension of your pillar, add full or cut Moderra Blocks.

Continue building courses by alternating between left and right Corner Blocks until you reach your desired height.

Moderra pillars are designed for easy construction using 6 x 6 posts.

Note: Consult a structural engineer when utilizing a Moderra pillar for structural support.

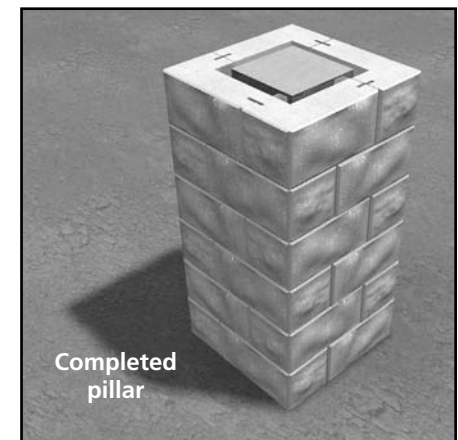
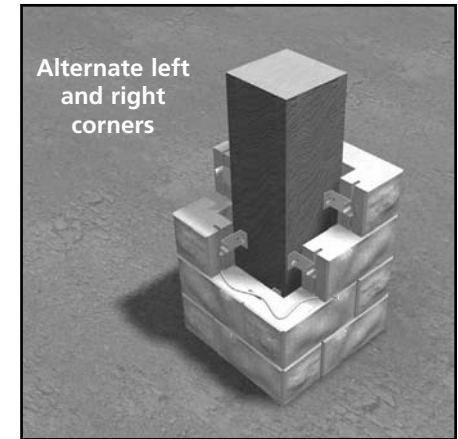
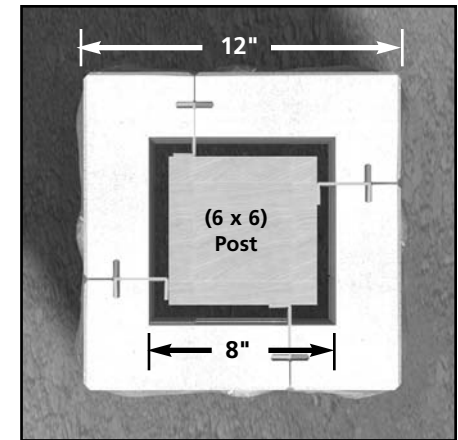

ASHLAR PATTERNS

Ashlar patterns are random and/or repeating block patterns.

Many different ashlar patterns can be created with scored and/or no-score 4" and 8" Moderra units.

Adding cut units will allow you to eliminate vertical and horizontal lines to create a truly unique installation.

When using cut Blocks, always use Trim Channel and a thin layer of Super-Stik. Alternatively, you can use a Moderra Tie. For details, see **USING MODERRA TIES**, pg. 4.

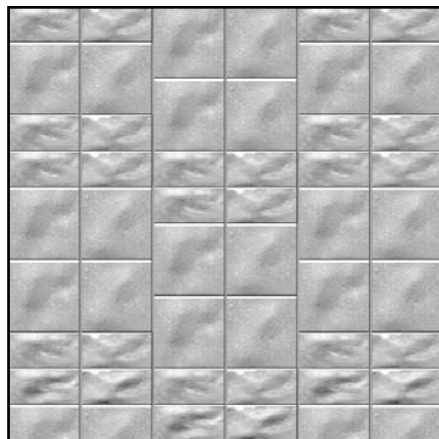
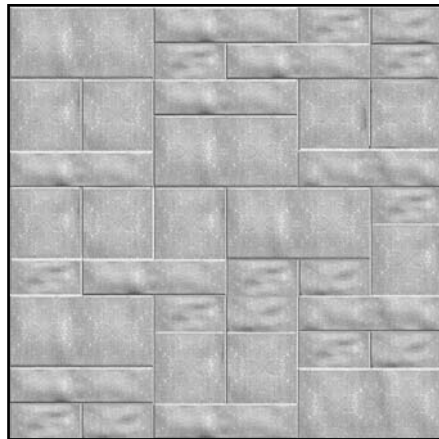
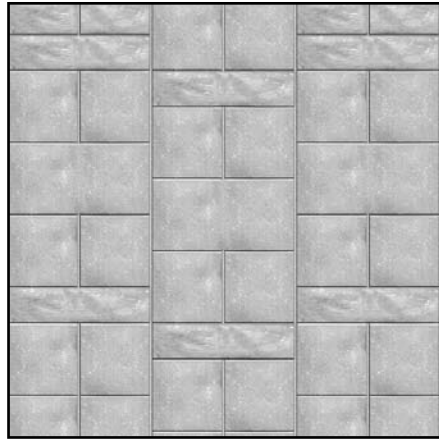

8" Moderra Block*
 Size 8"H x 16"W x 2.5"D
 Weight 25 lbs.
 Area 0.889 sq.ft.



4" Moderra Block*
 Size 4"H x 16"W x 2.5"D
 Weight 12 lbs.
 Area 0.445 sq.ft.



8" Moderra Corner Block*
 Size 8"H x 8"W x 2.5"D
 Weight 22 lbs.
 Area 0.889 sq.ft.



4" Moderra Left & Right Corner Blocks*
 Size 4"H x 8"W x 2.5"D
 Weight 8 lbs.
 Area 0.445 sq. ft.



4" Moderra Sill Block*
 Size 4"H x 16"W x 4.5"D
 Weight 18 lbs.
 Area 0.445 sq.ft.

*Actual block size, weight, compression strength, and absorption are manufactured to meet minimum specifications and may vary in your region.



Moderra Bracket
 Material Galvanized Steel



Moderra Tie
 Material Galvanized Steel



Moderra Trim Channel
 Material Aluminum
 Weight 3.16 lbs.
 Length 8 ft.



Moderra Starter Ledge
 Material Pre-drilled Steel
 Size 3"H x 3"W x .25"D
 Weight 49 lbs.
 Length 10 ft.



Super-Stik™
 Weight 10-1/2 oz.



www.moderra.com

GENERAL INFORMATION

EFFLORESCENCE, CLEANER AND SEALER

All cement products are susceptible to efflorescence or frost. While we know how and why efflorescence occurs, it is almost impossible to prevent.

When the cement, which contains lime, is mixed with sand, rock, and water and begins to harden, the free lime in the cement turns into calcium hydroxide. Although concrete products are solid, they contain millions of microscopic pores that go from the surface down into the interior. As the concrete starts to cure, water migrates to the surface through the pores, carrying with it calcium hydroxide. When the calcium hydroxide comes into contact with air, a hard white substance called efflorescence or frost is formed. This sticks to the surface of the concrete. This will continue as long as the concrete is curing.

Efflorescence will disappear, but it could take a few years. If the frost

is very obvious and detracts from your Moderra Concrete Veneer, you can remove it by using a standard masonry cleaner.

When using a masonry cleaner, follow the instructions given. After using the product, it is recommended to apply a concrete sealer on the surface of the Moderra Concrete Veneer to eliminate efflorescence from occurring again.

EXTERIOR APPLICATIONS

Make sure the application of Moderra Concrete Veneer products and the structure it is being applied to incorporate good building practices.

On exterior applications, the incorrect installation or absence of flashing, cant strips, gutters, and downspouts may result in diversion of water run-off onto finished surface areas. Masonry and other building products subjected to these conditions may develop staining, and when combined with

severe freeze-thaw conditions, may eventually suffer surface damage. The application of Moderra Concrete Veneer under these conditions is not recommended.

RESTRICTIONS

Use Moderra Concrete Veneer products only on buildings that meet current local building codes where applicable. Building code requirements vary. Check with local authorities for building code requirements in your area. Carefully read all Installation Guidelines before proceeding with your Moderra Concrete Veneer application.

TRADEMARKS AND PATENTS

Super-Stik, Moderra and the Moderra logo are trademarks of Alliance Concrete Concepts, Inc. U.S. Patent No. 6,374,552. Other U.S. and International patents issued and pending. Made worldwide under license from Alliance Concrete Concepts, Inc.

Distributed by:



A Division of:
Alliance Concrete Concepts, Inc.
325 Alliance Place NE
Rochester, MN 55906

Toll-free (877) 248-7456
Phone: (507) 536-4515
Fax: (507) 529-2879
www.moderra.com